

# Knight RIDER

*The Knight Aerospace  
Reusable Integrated Design for Expansive Roles*

A Multi-Role Architecture using Turbine Based Combined Cycle  
2004 RASC-AL Design Competition



Kristina Alemany  
Bjorn Cole  
Dominic Depasquale  
Mikhail Dvilyanski  
Jonathan Fornuff  
Jesse Hester  
Tom Jones  
Devin Kipp  
John Reeves  
Michael Schoenfeld  
Joo-Kyung Suh  
Bryan Tisinger  
Jimmy Young

Faculty Advisors:

**Dr. Dimitri Mavris**  
**Dr. John Olds**  
**Dr. Jan Osburg**

# I. Introduction

In the fall of 2003 a multi-disciplinary team consisting of graduate students from the Space Systems Design Lab (SSDL), the Aerospace Systems Design Lab (ASDL), and the Elevated Temperature Structural Durability Lab (ETSDL) was assembled at Georgia Tech. This project marked the first joint venture between these labs and brought together a diverse wealth of tools, knowledge, and experience, as well as a group of individuals with keen interest in the future of access-to-space vehicles.

The Knight RIDER revolutionary aerospace systems concept was formulated in response to a mock Request for Proposal (RFP) inviting architectural designs to enable six specific Design Reference Missions (DRMs) with a small set of common vehicles and components. Effects of this architecture-level approach were anticipated to be improved reliability and significantly increased economic viability due to cost sharing between multiple customers. The RFP specified horizontal take-off and landing capability, the use of Turbine Based Combined Cycle (TBCC) propulsion, and an operational timeframe of 2015-2030. The six DRM's can be summarized as follows:

- **DRM1:** Civil Cargo to Low Earth Orbit(LEO), *Customer:* NASA, *Requirement:* 20,000lb payload
- **DRM2:** International Space Station Crew Rotation, *Customer:* NASA, *Requirement:* 2 pilots, 4 crew
- **DRM3:** Long Range Strike Aircraft, *Customer:* USAF, *Requirement:* 8900 nmi range, 2-hour strike
- **DRM4:** Cargo to Geosynchronous Transfer Orbit(GTO), *Customer:* Commercial, *Requirement:* 10,000lb
- **DRM5:** High-Speed Global Transport, *Customer:* Commercial, *Requirement:* 6500 nmi range, 100 pax
- **DRM6:** Space Tourism Vehicle, *Customer:* Commercial, *Requirement:* 2 pilots, 6-16 passengers

Each DRM had the basic performance requirements listed above as well as more detailed requirements such as target reliabilities, g-load limitations, flight rates, and conformance to various government regulations. Each DRM was also coupled with specific economic requirements outlining limitations on initial investment costs, recurring costs per flight, and required return on investment. The economic scenario is summarized graphically in Figure I. The figure highlights the logistic and economic advantages of providing a single multi-role architecture to satisfy the needs of each customer.

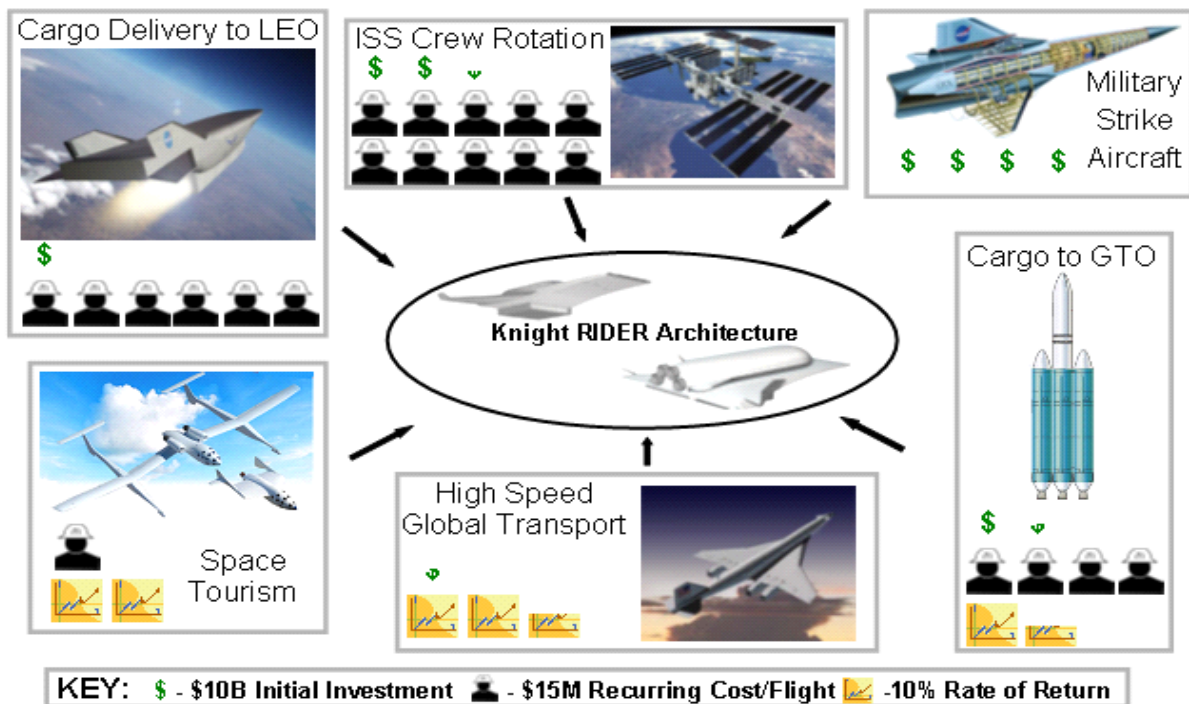

FIGURE I: ECONOMIC AND LOGISTIC SUMMARY OF DESIGN REFERENCE MISSIONS

## II. Knight RIDER Architecture

Zero-order and preliminary analyses resulted in a final architecture consisting of six vehicle elements. Five of these elements act as upper stages to a common booster that provides cruise capability for Long Range Strike Aircraft (LRSA) and Global Transport (GT) missions while also acting as an accelerator for access-to-space missions. This common booster takes the form of a hypersonic wedge and utilizes ten advanced afterburning turbine engines and ten ramjet/scramjet engines in an over-under configuration as the main propulsion system.

“Upper stages” for the two cruise missions are simple fuselages that remain attached to the common booster as “captive carriers.” The GT captive carrier contains a cockpit for 2 pilots and 100 standard first class passenger seats with additional room for amenities. The LRSA captive carrier is smaller in size and contains a payload bay for housing Enhanced Common Aero Vehicle (E-CAV) munitions while also containing a cockpit and seating for two pilots. The final configuration for both the mated GT and the mated LRSA appear below in Figures II and III.

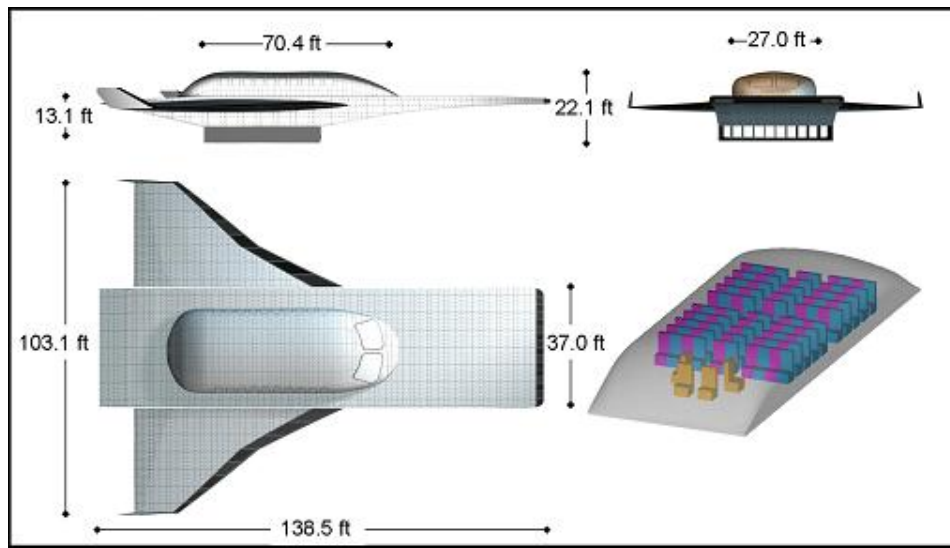

FIGURE II: GLOBAL TRANSPORT CAPTIVE CARRIER MATED TO CRUISER

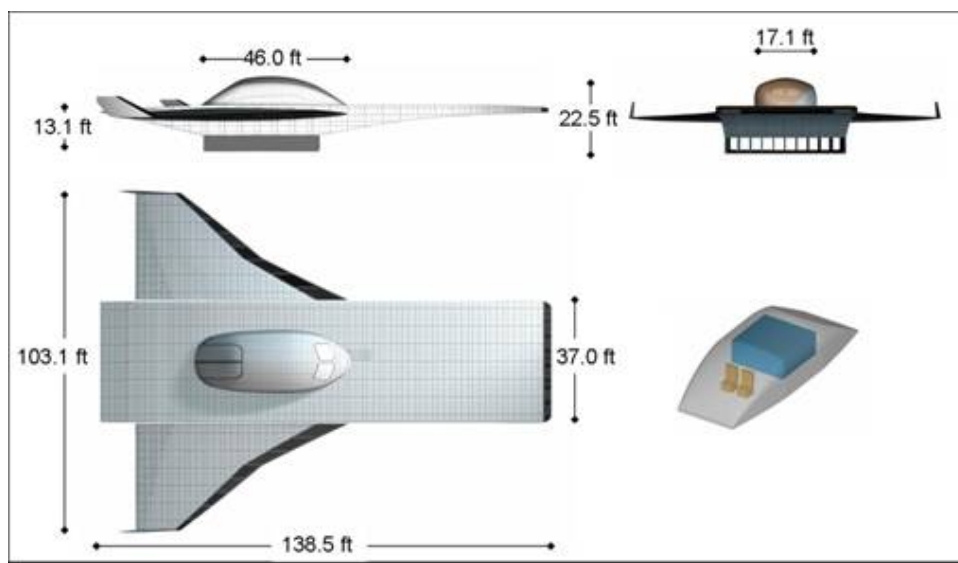

FIGURE III: LONG RANGE STRIKE AIRCRAFT CAPTIVE CARRIER MATED TO CRUISER

Minor modifications are necessary to enable access-to-space missions, where the booster takes on the role of an accelerator rather than a cruiser. The two cruising missions require the booster to sustain flight in the Mach 4 to 6 regime while access to space missions require the booster to attain a staging condition of Mach 8 carrying a much heavier load. The difference in flight regime and duration necessitates a different Thermal Protection System (TPS) between the two booster configurations. In addition, bulkier upper stages cause significantly more drag for access-to-space missions. This increased drag is overcome with the addition of a linear aerospike tail rocket that is operated through the transonic regime and during a pull-up maneuver prior to stage separation. These tail rockets have another benefit in that they allow for high-speed separation at a low dynamic pressure. Operation of the tail rocket requires a change to the aft-body of the common booster as well as the exchange of a modular liquid oxygen tank for an existing hydrocarbon fuel tank. These modifications are illustrated below.

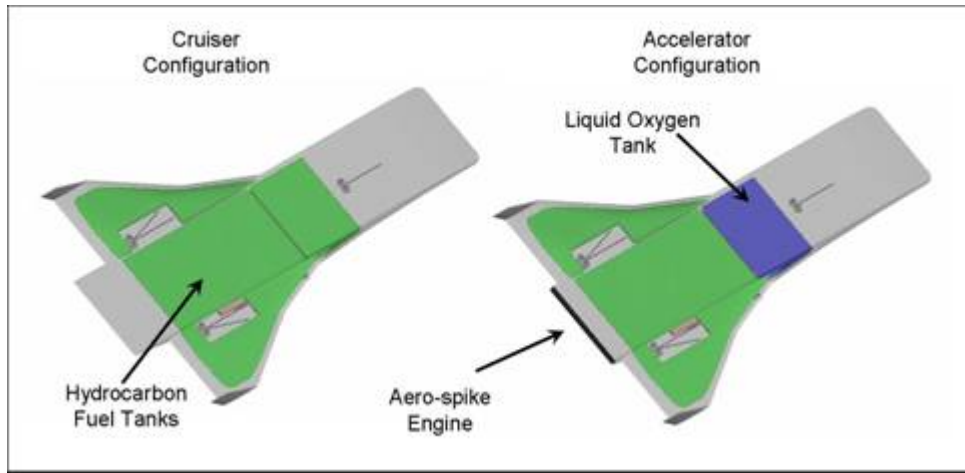

FIGURE IV : COMPARISON BETWEEN CRUISER AND ACCELERATOR CONFIGURATION

Two additional upper stages are required for the access-to-space missions. An unmanned stage is used for lifting payloads to low earth orbit while a manned upper stage performs the ISS crew rotation and space tourism missions. In order to lift payloads into geosynchronous orbits an orbital transfer stage (OTS) is required in conjunction with the unmanned upper stage. The mated unmanned arrangement and its internal configuration are shown below. Note that the OTS fits neatly inside the payload bay of the unmanned upper stage.

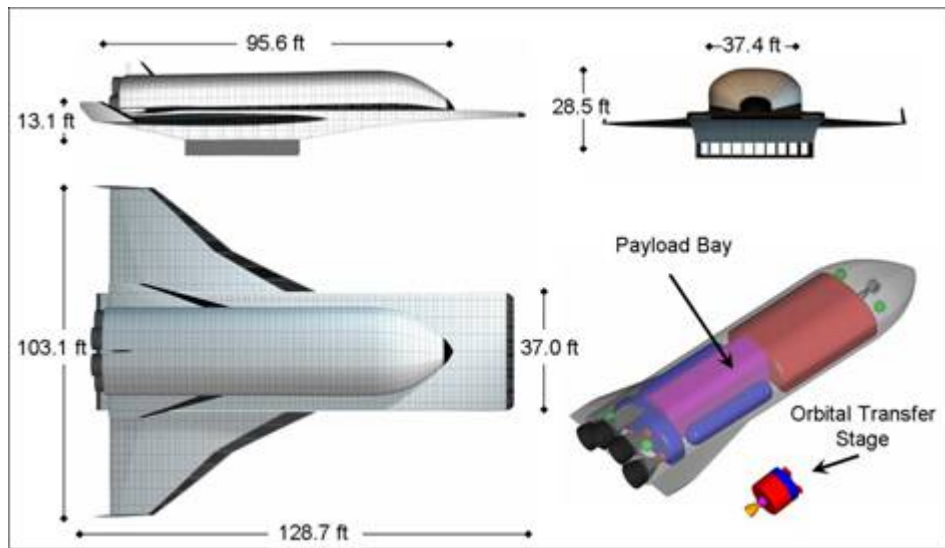

FIGURE V : UNMANNED UPPER STAGE MATED TO ACCELERATOR

Like the unmanned stage the manned stage is required to complete two missions: ferrying astronauts with small amounts of cargo to the International Space Station (ISS) and acting as a space tourism platform. The manned stage requires only a slight modification to do both missions; the seating arrangement is changed from six astronauts

and their supplies to fifteen passengers without supplies. The mated manned stage and its internal configuration appear below.

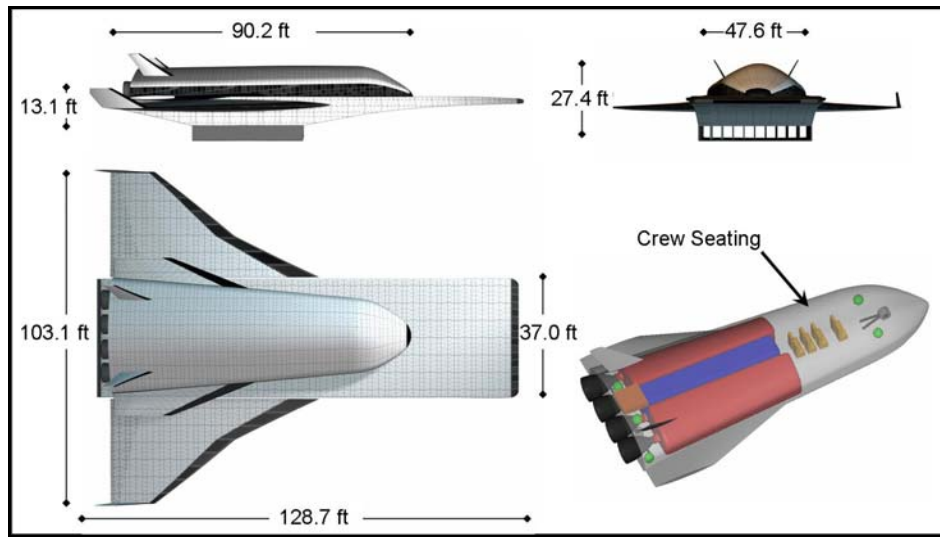

FIGURE VI : MANNED UPPER STAGE MATED TO ACCELERATOR

### III. Vehicle Architecture Selection

#### *Brainstorming and Down Selection*

The team began by brainstorming a wide variety of architecture concepts which could possibly accomplish all DRMs. These concepts ranged from a single vehicle configuration to specialized vehicles for each DRM. Many of these concepts were eliminated based on requirements set in the RFP as well as an operational readiness level of 2015. The final ranking of vehicle architectures was done using a Pugh matrix where each concept was rated against each other based on its technology risk, life cycle cost and vehicle safety. The top three architectures are shown below:

- A. – Common booster, three upper stages (reusable cargo, manned, expendable)
- B. – Re-configurable booster with three upper stages (reusable cargo, manned, expendable)
- C. – Two boosters (orbital/sub-orbital) with two upper stages (cargo/manned)

#### *Zero-Order Modeling*

In the context of this project zero-order models are simple spreadsheets that contain an input/output page and a series of basic aerospace design equations (e.g., Breguet range, rocket equation) to give general values for vehicle weight, size and cost based on fuel and engine type, staging conditions and general performance requirements. These models were used to provide a more detailed comparison of the top three architecture concepts. The benefit of using these models is that they are relatively easy to create and can perform rough order of magnitude estimations very quickly. The models were used as contributing analyses in an architecture selection tool to aid in down selecting to a single architecture.

#### *Architecture Selection Tool*

A central tenet of the design methodology of Georgia Tech is that most conceptual design decisions are made before sufficient design knowledge is available. It is desirable to bring preliminary design information forward to the conceptual stage in order to see the effects of decisions before they are made.

Knowing that extrapolation beyond recorded historical data sets can be misleading, zero-order models were given a set of noise variables that multiplied the effective specific impulse, structural weights and aerodynamic performance of the vehicles. These noise variables were run probabilistically to gain a confidence that proposed

systems would be feasible even if design assumptions were modified. Noise variables, along with different combinations of flight elements, lead to an enormous number of possible design combinations. Initial estimates placed the number of possible combinations at well over 1,000,000.

A unique aspect of this problem is that the vehicle, or fleet of vehicles, comprise a “system of systems” to achieve all of the missions laid out in the original RFP. The usual design process leads to the sizing and synthesis of a vehicle for a given set of critical conditions that are the product of a specific mission plan. In order to cope with multiple missions, a specialized tool was developed to scale a common set of vehicle flight elements to the most demanding mission to which a particular flight element would be assigned.

It was originally seen from the RFP requirements that the economic situation demanded that the large budget customers would have to lead the way for the smaller budget customers. Intuition would tend to drive the architecture selection to a one-size-fits-all solution, so that the various customers would pool their resources. On the other hand, it could be argued that this solution would lead to the designing of a vehicle intended to please everyone and would end up pleasing no one. The architectures would have to be allowed to compete against each other to see if the economic benefits of a common vehicle would outweigh the sub-optimal nature of such a vehicle.

### ***Final Architecture Selection***

The various combinations of flight elements were looked at for each of the three architectures shown above and the economic metrics of development cost, unit cost, recurring cost, and internal rate of return were compared against each other. It was found that each architecture seemed to work well for one or two DRM's, but failed to meet the others. Therefore a compromised architecture was developed that pulled together the idea of a common booster from architecture A and the idea of fully re-usable upper stages from architecture B. This process resulted in the Knight RIDER architecture as presented above:

**“Common” Booster:** RTA/Ramjet/Scramjet, Hydrocarbon Fuel, Staging at  $M = 8$

**Manned Upper Stage:** Rocket, LOX/LH2

**Unmanned Upper Stage:** Rocket, LOX/LH2

**LRSA/GT Captive Carriers:** No propulsion

## **IV. Preliminary Analysis Phase**

In order to facilitate the design of this complex architecture the design team was broken down in a series of sub-disciplines where each team member could become an expert in their particular design area. This allowed for the experience and knowledge of each team member to be used most efficiently throughout the project. The design process itself was iterative in nature, where the results from one discipline would need to be passed to the next discipline and the results of that discipline would have to then be passed back to the preceding discipline until a converged solution was obtained. A breakdown of the flow of information between each discipline can be seen in Figure VII, the dots between the different disciplines represent that information is being passed between the two.



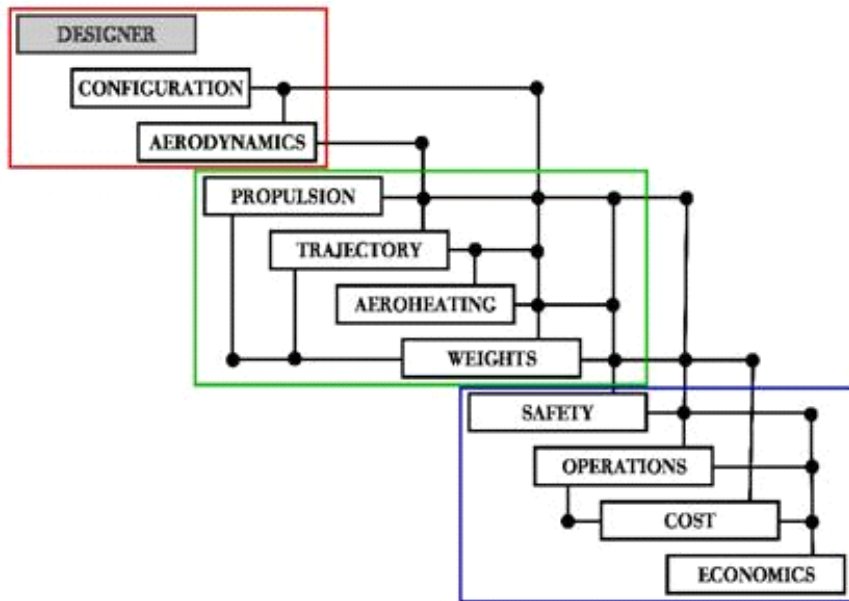

FIGURE VII: DESIGN STRUCTURE MATRIX

The following sections outline the various disciplines used in developing the Knight RIDER architecture.

### *Aerodynamics and Aero-heating*

Vehicle aerodynamics were modeled using a NASA legacy code (APAS) which calculates lift and drag coefficients based on vehicle reference area. This reference area was then used to scale the lift and drag of the vehicle as it changed throughout the design process. In order to verify these aerodynamic results a higher fidelity CFD analysis was conducted at a few select flight conditions. The results of this analysis verified the accuracy of the lift and drag coefficients previously obtained from APAS. Samples of the CFD results obtained are shown in Figure VIII below.

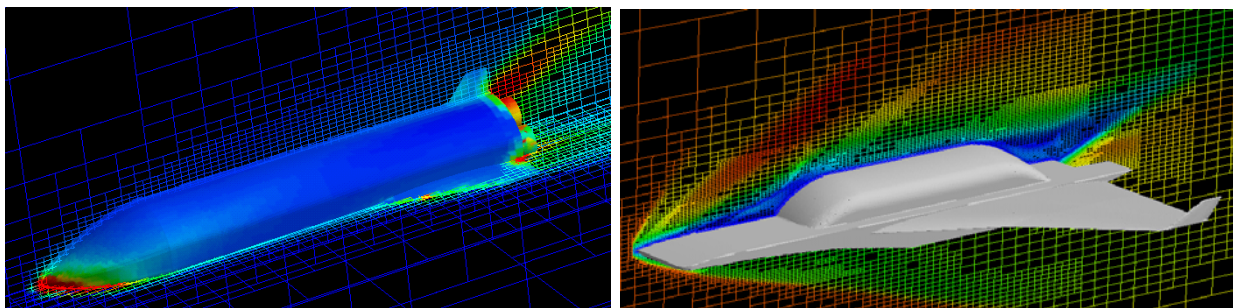

FIGURE VIII: NASCART AERODYNAMICS VERIFICATION

The Thermal Protection System (TPS) for a vehicle traveling through the atmosphere at high velocity is an extremely important design consideration in terms of structural weight and integrity. The TPS must be chosen to withstand not only the peak temperature reached during the trajectory, but also the total integrated heat load over the entire flight, while maintaining as low a structural weight as possible without sacrificing the safety of the vehicle. In order to facilitate this a one-dimensional finite element heat transfer analysis program was created to accurately size the TPS for each vehicle and its corresponding mission. Figure IX illustrates the layout of TPS on both the booster and upper stage configurations.

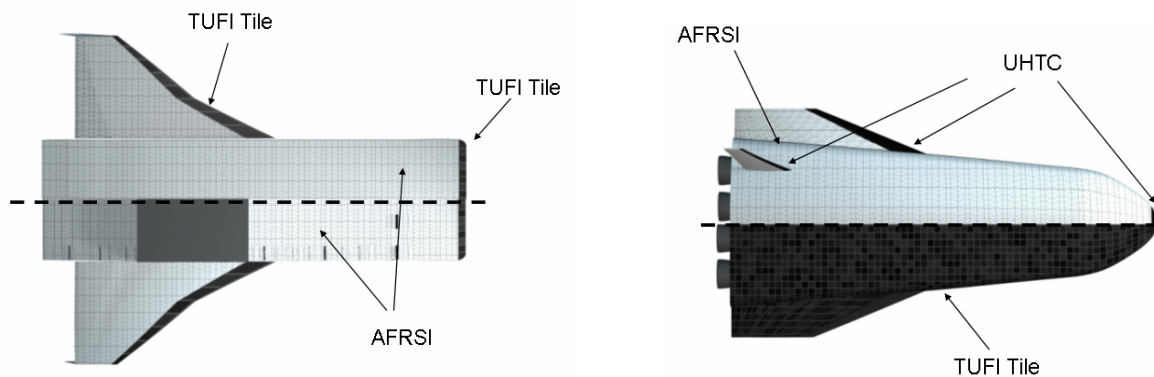

FIGURE IX: VEHICLE THERMAL PROTECTION SYSTEM LAYOUT

### ***Propulsion***

Turbine based combined cycle (TBCC) propulsion has been asserted to be an enabling technology for future space access, global transport, and military global strike architectures. Turbine based combined cycle propulsion concepts feature reduced maintenance and use conventional fuels allowing for airline-like operations and reduced cost<sup>1</sup> over conventional all-rocket systems. The Knight RIDER TBCC common booster features ten advanced turbine engines together with ten dual mode ramjet/scramjets in an “over-under” configuration as is shown in Figure X.

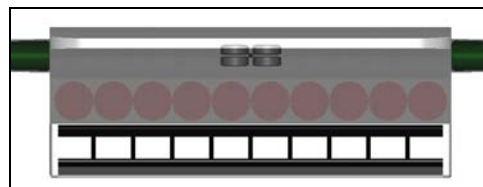

FIGURE X: TBCC OVER-UNDER ENGINE ARRANGEMENT

The turbine engines were sized using a vehicle thrust-to-weight ratio of 0.6 at take off. The performance and weight of these engines is based on the Revolutionary Turbine Accelerator (RTA) program goals which include a 35 percent increase in Mach number, a 375 percent improvement in T/W, and improved critical component life over current state of the art technology, such as the J-58, by the year 2015<sup>2</sup>. A key aspect of the RTA program is an afterburner producing an additional 50 percent thrust at transonic Mach numbers<sup>2</sup>. Despite the RTA program cancellation, we believe that these metrics are representative of technology development (via the VAATE/IHPTET and NASA Aeronautics Enterprise programs) for engines performing up to Mach 2.5, which is the Knight RIDER flight regime.

The dual mode ramjet/scramjet engines provide thrust for each booster in the Mach 2.5 to Mach 8 range. These engines use the same fuel type as the low speed turbine engines, eliminating the need for alternate tanks and simplifying ground operations. For the space access missions (DRMs 1,2,4, and 6), the ramjets operate from Mach 2.5 to Mach 6 and then transition to scramjet mode for Mach numbers 6 to 8. The global transport (DRM 5) and the global strike (DRM 3) missions have a maximum speed of Mach 4 and Mach 6 respectively, and thus do not require scramjet mode operation.

<sup>1</sup> Bartolotta, P. & McNelis, N. “NASA’s Advanced Space Transportation Program – RTA Project Summary” National Aeronautics and Space Administration. Glenn Research Center. Cleveland, OH. April 2002.

<sup>2</sup> NASA. “Revolutionary Turbine Based System: Key to Enabling Tomorrow’s Propulsion Systems. Turbine Based Combined Cycle (TBCC)” Glenn Research Center. <http://tbcc.grc.nasa.gov/rta.shtml> Accessed 17 January 2003.



The four upper stage engines on both the manned and unmanned configuration are identical in order to lower the life cycle cost of the vehicle. These engines were designed to use liquid oxygen and liquid hydrogen in order to maximize the performance of the engine. The important sizing parameters for the upper stage engines are provided in Table I. The main engines of the upper stage are also capable of performing a de-orbit burn by throttling a single engine to 30%. For maneuvering in orbit, the upper stage has a reaction control system (RCS). At this conceptual design level, the RCS was not specifically designed but mass was allocated for a RCS system in the vehicle weights breakdown.

The delivery of cargo to GTO (DRM 4) requires an orbital transfer stage to boost the payload from the upper stage in LEO to GTO. The orbital transfer stage was sized to deliver the necessary velocity change for an orbit transfer from a 100 nmi x 28.5 degree circular orbit to a 300 nmi x 19,500 nmi x 28.5 degree orbit during the first burn, and then to a 19,500 nmi x 27 degree circular orbit during the second burn. The orbital transfer stage specifications are also summarized in Table I.

TABLE I: SUMMARY OF ROCKET ENGINES DESIGNED FOR KNIGHT RIDER

Parameter	Aerospike	Upper Stage Engines	GTO Orbital transfer stage
Number	1	4	1
Cycle	Expander	Expander	Pressure Fed
Throttle (%)	100	109	100
Vacuum Thrust (lb)	313,650	75,230	11,720
Vacuum Isp (s)	343.3	463.9	411.2
Oxidizer/Fuel type	LOX/Kerosene	LOX/LH2	LOX/LH2
O/F Ratio	2.9	5.8	7
Expansion Ratio	60	275	50
Chamber Pressure (psi)	900	1950	350

### Trajectory

Two different classes of trajectories, access-to-space and cruise, were required to accomplish the six design reference missions. These trajectories were simulated utilizing a three degree of freedom, untrimmed trajectory optimization program. The first type of trajectory, access-to-space, includes the unmanned missions to LEO and GTO, the manned mission to ISS, and the space tourism mission. The mission profile for an access-to-space mission is illustrated in Figure XI.

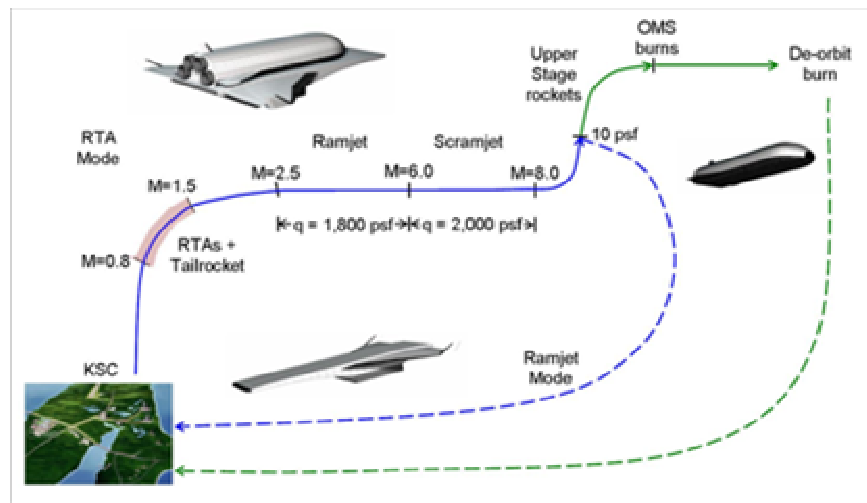

FIGURE XI: MISSION PROFILE FOR ACCESS-TO-SPACE MISSIONS

The baseline mission begins with a horizontal takeoff from Kennedy Space Center – although other launch sites are possible as specified in the RFP. The transition points between the three engine types were chosen as a trade between when the performance of the next engine mode surpasses the diminishing performance of the previous engine mode. Furthermore, while running on ramjets and scramjets, a dynamic pressure profile is followed, in order to stay within the structural limits of each engine type. The maximum dynamic pressure is 1800 and 2000 psf for ramjet and scramjet mode, respectively.

Once the scramjets reach Mach 8.0, a pull-up maneuver is performed using the tail rocket in order to reduce the dynamic pressure for staging. Staging occurs at a dynamic pressure of 10 psf, Mach 7, and an altitude of 208,000 feet. Following staging, the booster stage flies back to its launch site on ramjet mode at Mach 6.0. Using its main engines, the upper stage continues on to its transfer orbit. Figure XII illustrates the trajectory for the unmanned to LEO and manned to ISS missions. The solid red line represents the unmanned mission while the dashed blue line represents the manned mission. Altitude and dynamic pressure are plotted as a function of time. As can be seen, both trajectories are very similar and follow the mission profile described above.

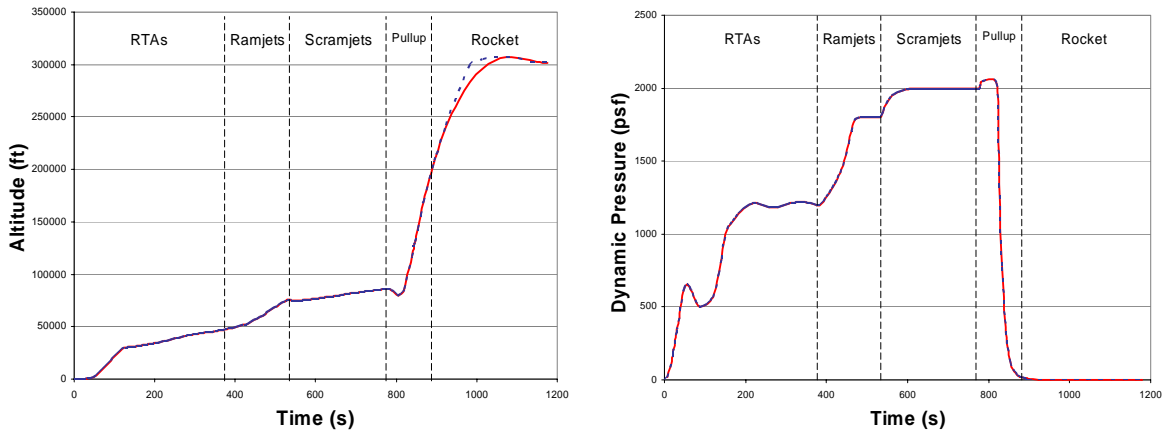

FIGURE XII: ALTITUDE AND DYNAMIC PRESSURE PLOTS FOR ACCESS-TO-SPACE MISSIONS

An outline of both cruise missions is shown below in Figure XIII. As specified, the Global Transport cruises at Mach 4, with a minimum range of 6500 nmi, approximately the distance from Los Angeles to Sydney at a total trip time of 3.15 hours. The LRSA mission is capable of delivering, as specified, a 15,000 lb payload to a range of 8,500 nmi in less than three hours. In order to obtain enough fuel for the fly-back, one KC-10 refuel tanker is required.

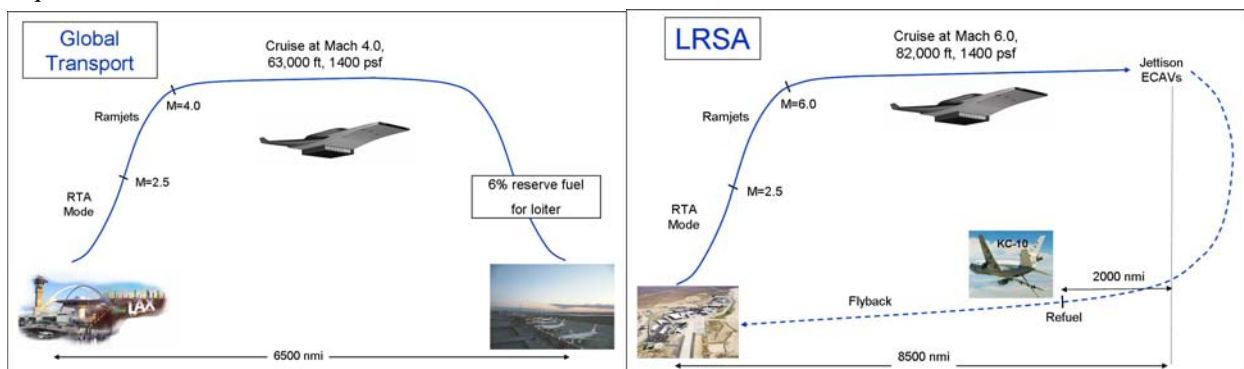

FIGURE XIII: MISSION PROFILE FOR CRUISE MISSIONS

### Weights and Sizing

The weights and sizing team was tasked with determining the weight of each vehicle based on its configuration and required mass ratio. This was done through the use of historically based Mass Estimating

Relationships (MERs) developed for various space access and cruiser type vehicles. Several MS Excel spreadsheets were created to construct a weights model for each of the vehicle configurations. These weights would then be iterated with the propulsion and trajectory disciplines in order to converge on an optimized vehicle configuration. This was accomplished by allowing the vehicle to photographically scale up and down as it was matched to the outputs from trajectory and propulsion.

It is worth explaining here how all these components were fit together to create a workable architecture. On the space side, there is need for a booster and 2 different upper stages – manned and unmanned, with the unmanned stage having two derivatives, one carrying 20,000 lbs of payload to LEO and the other carrying 10,000 lbs to GTO. However, the same vehicle is used for both of the unmanned derivatives, with the latter one utilizing an orbital transfer stage as part of its payload in order to take the useful payload up to GTO after the vehicle delivers it to low earth orbit. After both the manned and unmanned stages are designed, the larger (heavier) one of the two is taken as the payload for the booster, and the booster is then sized accordingly, making it slightly oversized for the other mission, but inherently making it more robust in case a more demanding mission is ever required. On the sub-orbital side, a non-staging booster that does not possess a tail-rocket or liquid oxidizer tank is utilized with two captive carriers designed to fit as its payload; one carrier for the GT mission and the other for LRSA. Once again, the more demanding of the missions is taken as the base and the booster is designed to carry out this mission; in this case this is the Long Range Strike Aircraft. In the end, the final size of both the space access and cruise booster must be equal since they are meant to be a single common vehicle. A final weight breakdown for space access and cruiser missions is shown in Figure XIV:

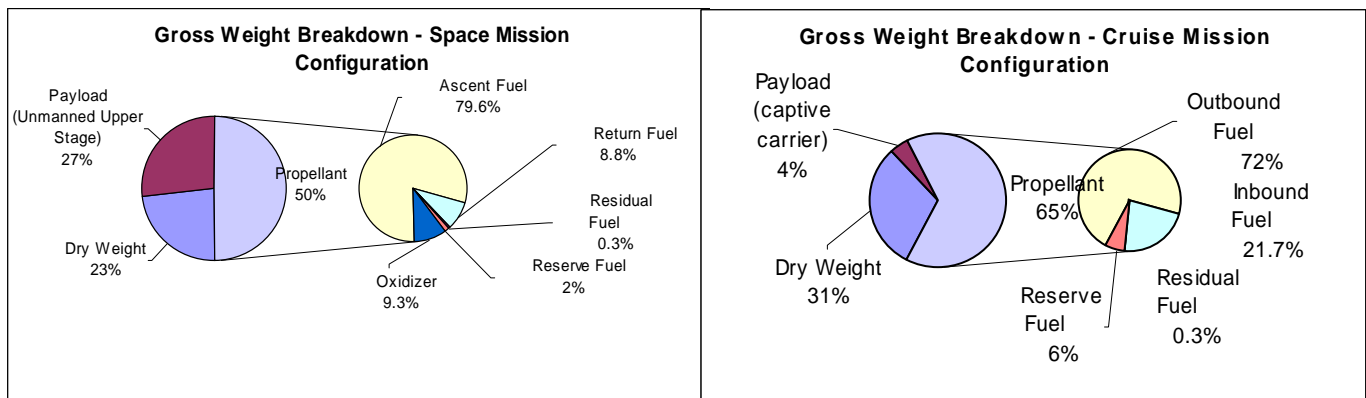

FIGURE XIV : GROSS WEIGHT BREAKDOWN – SUBORBITAL AND ORBITAL MISSIONS

### ***Life Cycle Cost and Reliability***

The life-cycle cost (LCC) discipline is essential because it deals with the economic and operational aspects of the vehicle configuration(s). It consists of some of the most visible and commonly tracked characteristics of any launch vehicle. The cost and operational efficiency determines if the vehicle is even economically viable since there is usually a somewhat small margin of money allocated to the project. One of the primary goals of any conceptual designer is to ensure that the architecture is economically feasible while at the same time operationally acceptable.

### **Operations**

One of the biggest drivers of cost is the ground operations between flights. This phase encapsulates everything from the touch-down of the prior flight to the launching of the next flight. A general rule is that the longer that the vehicle is on the ground, the more cost is accumulated for each flight. Knight RIDER consists of several different vehicles that make up an overall architecture, thus there is a disparity of operation time and cost. The LCC analyses, therefore, were performed for each DRM individually, and estimates in turnaround time, flight rate, and corresponding recurring costs were generated in each case using a historical data-based Excel tool.

Another analysis was performed using Discrete Event Simulation (DES) with Arena Software<sup>3</sup> that generated an 80% confidence value on the number of hits that could be obtained using the Long-Range Strike

<sup>3</sup> <http://www.arenasimulation.com/>

Aircraft. This analysis used a LRSA DES model that included loss of vehicles due to combat, and was replicated a thousand times in order to generate the confidence value. Using this tool determined how many vehicles/launch sites would be needed to meet the requirements specified in the LRSA's DRM with the set confidence level of 80%. Similar DESs were run for the remaining missions to ascertain the confidence of meeting the requirements and how these confidences would change with more demanding schedules.

## Safety

Another discipline that was part of the LCC group was safety and reliability. A historical data-based Excel tool developed at Georgia Tech (GT-Safety II) was used to analyze the architecture from a DRM point of view. Different assumptions were made for different DRMs dealing with a range of mission profile characteristics such as abort options and engine cut-off probabilities. Statistics for Loss of Mission (LOM), Loss of Vehicle (LOV) and Loss of Crew (LOC) were forecasted for each of the missions.

## Development and Production Costs

The non-recurring costs of the Knight RIDER architecture take into account the investment cost required to develop the initial operating fleet. This is broken down into the development cost (DDTE) as well as the vehicle production costs (TFU). The DDTE and TFU are developed from weight based historical curve fits taken from the NASA Air Force Cost Model (NAFCOM)<sup>4</sup>. A complexity factor is typically added to these cost estimating relationships (CERs) in order to account for the use of advanced material which would decrease the vehicle weight but not necessarily the vehicle cost. A breakdown of these cost for each DRM are shown in Table II. The initial fleet costs take into account a 85% learning effect for the number of vehicles developed.

TABLE II: DEVELOPMENT AND PRODUCTION COSTS [\$M]

	Cargo to LEO		Crew to ISS		LRSA		Cargo to GTO		Global Transport		Space Tourism	
Booster DDTE	3,122		3,122		4,825		0		0		0	
2 <sup>nd</sup> Stage DDTE	4,031		4,579		526		416		1,426		0	
Booster TFU	1,076	1 ea	1076	2 ea	1,355	6 ea	899	1 ea	937	10 ea	0	1 ea
2 <sup>nd</sup> Stage TFU	699	2 ea	732	2 ea	69	6 ea	538	1 ea	259	10 ea	605	1 ea
Initial Fleet*	9,567		11,317		13,895		1,853		13,391		605	

\*An 85% learning Curve was used for multiple engines and airframes built

## Economic Business Analysis

One of the most important benefits of the Knight RIDER architecture is that much of the development cost can be spread out over multiple groups reducing the overall project risk. The architecture allows for most of the up-front development cost to be shared by the Air Force and NASA, which in turn allows for an economically viable solution to be developed for the three commercial markets. This is accomplished by establishing a joint venture between the Air Force and NASA where a common booster is developed to meet the needs of both space access and a long range strike aircraft, with slight modifications made to the booster to accommodate for specific mission differences. They would in turn develop a second stage specific to each; manned and unmanned rocket propelled upper stages for NASA and an high-speed aerodynamic carrier for the Air Force. From this development effort a series of commercial derivatives would be established. The LRSA would be transformed into a high speed Global Transport with the addition of a 100 passenger captive carrier. The unmanned NASA vehicle would transform into a commercial launch vehicle and the manned stage would be used to develop a space tourism investment. With a majority of the initial investment offset by the government, these traditionally difficult markets would now become economically viable. An outline of this development plan is shown in Figure XV.

<sup>4</sup> <http://nafcom.saic.com/>

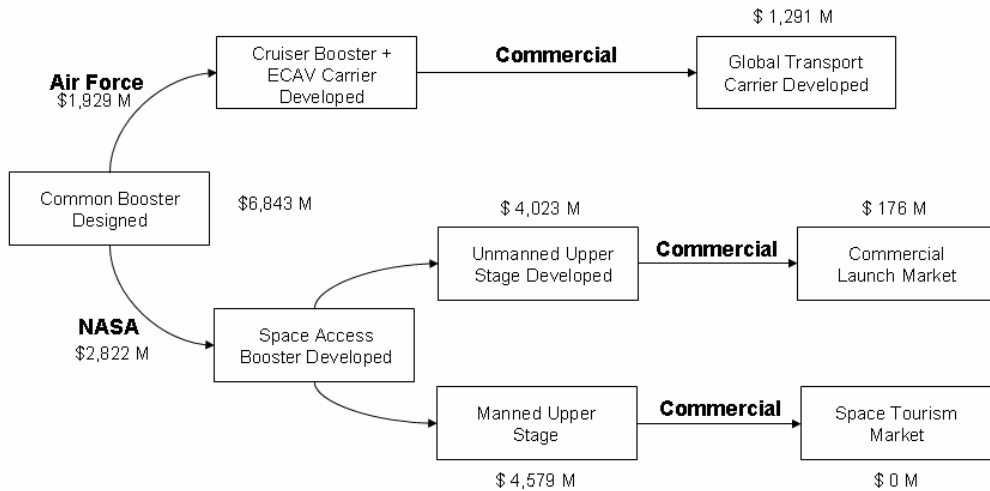

FIGURE XV: DEVELOPMENT TIMELINE

### Life Cycle Requirements

Almost every goal was met with the exception of the DRM1 LOV requirement, the DRM2 LOC requirement, and the DRM6 ticket price requirement. The first two exceptions pertain to extremely aggressive reliability goals for the LEO and ISS mission. It has been determined that these goals are not viable for the time frame set for this design (first flight 2015). The DRM6 ticket price exception translates to a higher ticket price than was initially targeted for the tourism mission. With the growing interest in space tourism, the market of people willing to pay \$1.95M for a ticket as opposed to \$1M is believed to be big enough to sustain the estimated flight rate.

## V. Technology Study

Technology influence has always been difficult to evaluate when developing aircraft or space vehicles. It is usually not economically feasible to test the effects of different combinations of technologies because there are generally too many combinations, and in some cases the effects are not completely known at the time of design. In order to study the effects of technology additions to the Knight RIDER architecture, a physics-based synthesis tool was used that could rapidly provide estimations of key vehicle performance and economic parameters in order to explore technology influences.

### *RET and RASAC*

The Requirements Exploration Tool (RET)<sup>7</sup> consists of several discipline codes all brought together by the Rapid Access to Space Analysis Code (RASAC). This tool allows users to quickly input discrete design variables or design variable ranges to assess a potential vehicle's viability. The first step was to identify and research technologies that have a potential benefit on the design variables. Fifteen technologies resulted from this study, impacting various subsystems such as aerodynamics, TPS, propulsion, structures, and materials. One example includes ARMOR (Adaptable, Robust, Metallic, Operable, Reusable TPS), which is a metallic thermal protection

<sup>7</sup> ("Parametric Trades for Two-Stage-to-Orbit" Final Report, Aerospace Systems Design Laboratory, Georgia Institute of Technology, Atlanta, GA, USA; March 2004)

material that is damage resistant and waterproof, unlike the Space Shuttle tiles. The fifteen technologies studied are listed in Table III.

TABLE III: CANDIDATE TECHNOLOGIES

	<b>Technology Name</b>
T1	Adaptive Performance Optimization
T2	Cold-Cathode Electron Emission
T3	Forward-Facing Jet Injection
T4	Ultra High Temperature Ceramics
T5	Chemical Vapor Deposition
T6	Adaptive Metallic TPS
T7	Durable Flexible Reusable Surface Insulation
T8	Protective Coating for Ceramic Materials
T9	Ceramic Thermal Barrier Coating
T10	Active Blade Damping
T11	Multi-Port Lean Direct Injector
T12	Four-Stage Compressor
T13	Adaptive Wing Shaping
T14	Airframe Methods
T15	Lamilloy Film Cooling

After the technologies were chosen, both the positive and negative impacts of the technologies on 20 of the most important variables were quantified. For instance, ARMOR decreases the replacement percentage of the TPS on both the booster and the upper stage. A Technology Impact Matrix (TIM) was developed that tabulated each of the technologies against each of the vehicle variables. Next, compatible combinations of up to two technologies were analyzed. For a combination of technologies, the impacts of each technology on the design variables are additive. For this study, it was decided that combinations of only two technologies would be considered for reasons of feasibility and uncertainty. With the incompatible combinations eliminated (for instance, ARMOR is physically incompatible with Ultra High Temperature Ceramics because it is applied to the same part of the vehicle) a total of 116 combinations, including the baseline that has no technologies for comparison, were considered. A 116x20 matrix was constructed with the k-factors and the design variables. RET uses this matrix to apply the k-factors to their respective design variables. For example, one of the technologies effects combustion efficiency by 10%, so for one case when this technology is applied to the baseline, RET will increase the baseline value of combustion efficiency by 10% and use this value in its calculations.

RET generates the output values of the metrics for the 116 cases. For each metric, each technology combination was compared to the baseline and plots were made that show the percent change from the baseline. For all the metrics, a decrease, either in mass or cost, is a benefit. The technology combinations for these “best” benefits were recorded for each metric.

The frequency with which a technology occurs in one of the “best” combinations was recorded. The four best technologies resulting from this study, and the four recommended for further development, are: ARMOR (T6), Chemical Vapor Deposition (T5), Cold Cathode Electron Emission Control (T2), and Protective Coating for Ceramic Materials (T8). The technology impact forecasting allowed the group to conclude that the addition of one or two technologies can greatly enhance the feasibility and viability of Knight RIDER.

## VI. Outreach

As part of our Outreach Program, we were fortunate enough to take part in Space Day at Nicholson Elementary School in Marietta, Georgia. During this day, our team members spoke about various topics in space science and technology. One topic that caught the most attention from the children is Mars exploration. Although



some concepts were hard for children to comprehend, it was exciting to watch them show so much enthusiasm and interest. Also, we were surprised at how well informed they are about space science history and current missions. Great success in capturing the children's imagination came with various demonstrations that occurred throughout the day. As expected, the demonstration involving model rocketry caught the most attention. During this demonstration, elementary school students were split into groups and specific tasks were given to them to help out with the launch process. At the end of the day, it was very fulfilling to hear the children mention their dreams of becoming an astronaut and a rocket scientist.



FIGURE XVI: PRESENTING AT NICHOLSON ELEMENTARY SCHOOL

## VII. Conclusion

Knight RIDER is a system of vehicles that contains a “common” booster, two upper stages, and two captive carrier elements to accomplish six diverse missions. The revolutionary design was produced in response to a mock RFP detailing specific performance, reliability, and economic requirements. All performance requirements and nearly all economic requirements were met. Furthermore, the economic benefit of a combined solution for multiple customers was demonstrated. Advancing technologies were identified that would improve vehicle capability and booster commonality within the same architecture.